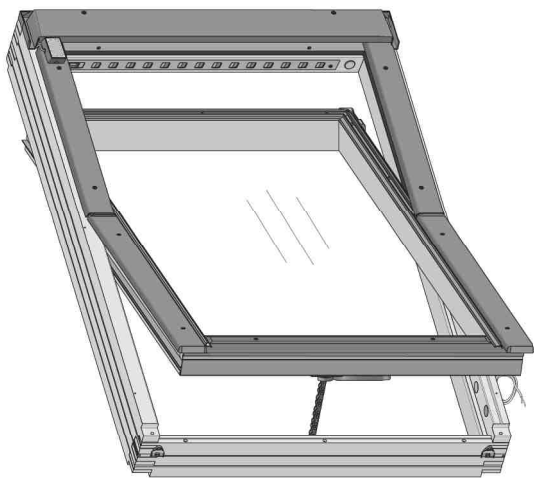

ELECTRICALLY OPERATED ROOF WINDOW**FTP-V WiFi**
FTU-V WiFi

WIRING DIAGRAM	3
SAFETY RULES	4
IMPORTANT INFORMATION	4
CONTROL PANEL	5
ADDITIONAL INFORMATION	5
MANUAL CONTROL	6
WiFi DEVICES COMPATIBILITY	6
QUICK START	7
ADD DEVICE	8
CONTROL VIA APPLICATION	9
COMFORT POSITION	10
WINDOW CALIBRATION	10
WARRANTY	11

Dear Sir/Madam! Thank you for purchasing the product from FAKRO. We do hope that it will meet your expectations. To ensure appropriate functioning of the product, please peruse this User Manual.

The FT_FP_WiFi roof window ensures maximum comfort of using the attic space. You can control your windows by means of smartphone app locally or from anywhere in the world. Set the comfort position, create a schedule to suit your needs and control the status of your windows. Share data with household members. Use the attic safely: rain sensor monitors weather conditions outside, reed switch sensor monitors the window status in cooperation with the alarm system.

Equip your window with the external ARZ WiFi roller shutter, AMZ WiFi awning blind or internal ARF WiFi blackout blind and control the temperature and light access within the attic space.

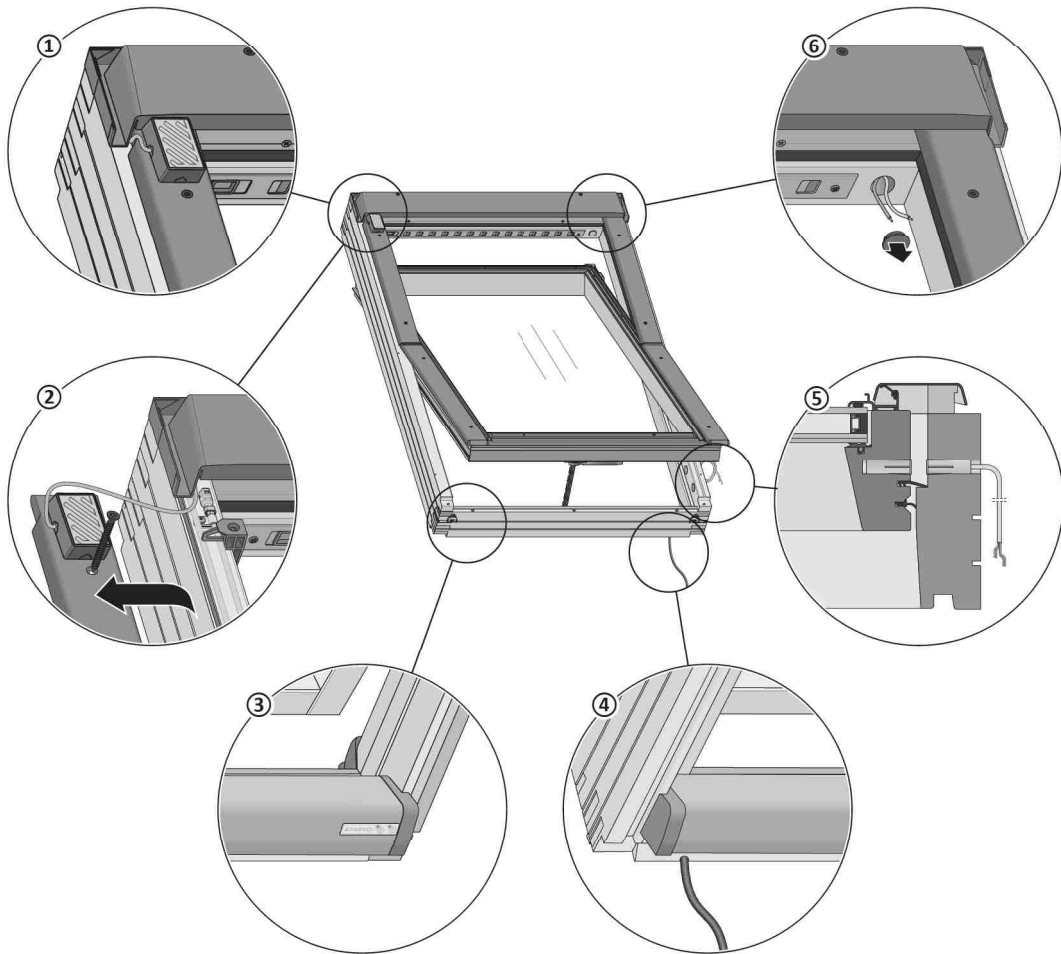

WINDOW STRUCTURE

①	Rain sensor	④	Power cable 3x1.00 mm ²
②	Power supply of external accessory 15V DC, 2x0.5mm ²	⑤	Reed relay
③	Control panel	⑥	Power supply of internal accessory 15V DC, 2x0.25mm ²

TECHNICAL SPECIFICATION

Power voltage:

230V AC

Rated power:

12W

Current limiting:

Yes

Power cable:

3x1mm²

Working temperature:

-10 to +65°C

Actuator dimensions:

260/47/32 mm

Chain extension speed:

4.25mm/s

Chain pushing force:

250N

Closing force:

250N

Limit switch:

Overload when closing.

Contact when opening

Chain outreach:

240mm

Protection class:

IP30

Radio protocol:

WiFi

Radio reach:

Up to 20m in a building

Radio frequency:

2.4 GHz.

REED RELAY

Maximum switching voltage:

48V DC/AC

Minimum switching current:

400mA DC/peak AC

Degree of protection:

(PN-EN50131-2-6:2009): 2

Atests:

VdS Germany, INCERT Belgium,

SBSC

Cable cross-section:

4x0.25mm²

WIRING DIAGRAM

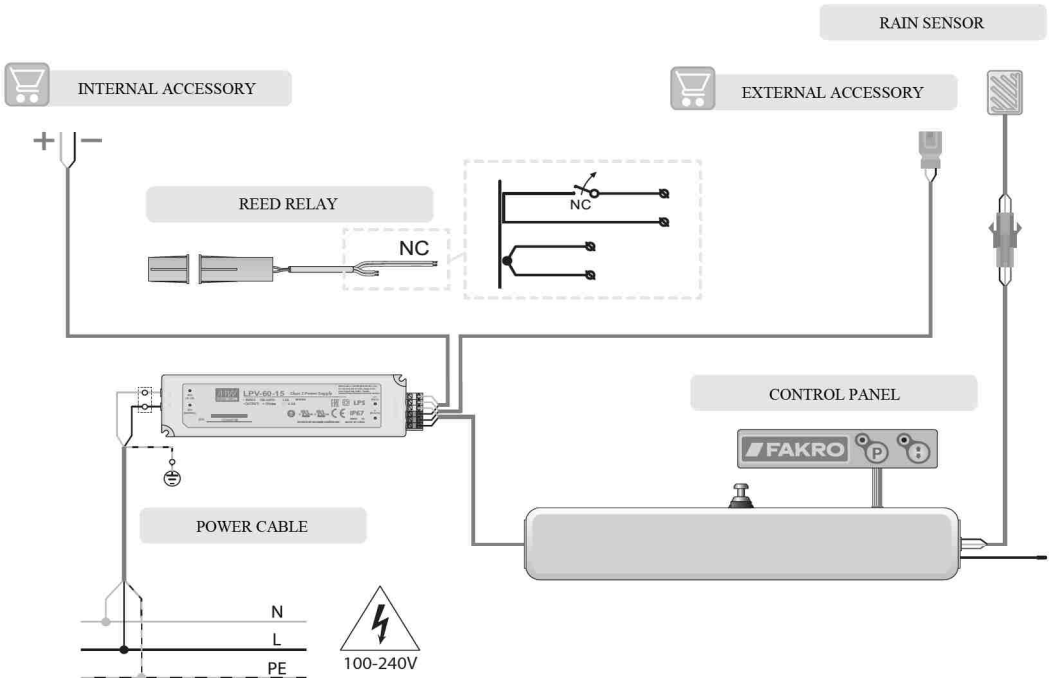

SAFETY RULES



Danger of crushing! When closing, the actuator exerts the force of 250N (app. 25 kg)!



The window may close automatically (without warning) if it is connected to the control unit or rain sensor.

It is required to observe the following recommendations when installing the FTP-V, FTU-V WiFi window:

- Safety requirements should be particularly respected. The use of the electric actuator installed in order to operate the window creates a risk of injury. Although the mechanism of the actuator is equipped with an overload switch, forces present there are strong enough to cause physical injuries. When closing the window, the actuator exerts the force of 250N (app. 25 kg)!
- If the FTP-V, FTU-V WiFi window is easily accessible, e.g. the lower window edge is situated lower than 2.5 m above the floor level, then special safety measures should be adopted so as to prevent health hazards.
- This equipment is not designed for use by people (including children) with limited physical, sensory or mental ability, or by people that do not have experience or knowledge of the equipment, unless it is done under supervision or according to the product original user manual provided by a person responsible for safety. Do not allow children to play with the equipment.
- After unpacking, check the window elements for any signs of mechanical damage.
- Installation should be carried out in accordance with manufacturer's instructions by a qualified professional.
- Before connecting the window make sure that the power supply corresponds with the voltage specified on the data plate.
- Plastic containers used for packing should be stored out of children reach as they may be a potential source of danger.
- The window should be used according to its intended design. FAKRO shall not be responsible for any consequences being the result of improper window use.
- Any activities related to cleaning, adjustment or dismantling the electric parts of the window should be preceded with disconnecting it from the power supply.
- Electric parts must not be washed using solvent-based substances or open stream of water (do not immerse them in water).
- Any repairs of the window should be carried out by service authorised by the manufacturer.

IMPORTANT INFORMATION

1. To prevent water vapour condensation on the window in winter seasons install properly the lining and place the heat source directly beneath the window.
2. Applying the air inlet allows for automatic exchange of air with the environment under the influence of pressure difference. It is possible when natural ventilation in the room is working properly. Manual adjustment of the air inlet opening is possible.
3. Operating the window by means of the actuator enables to increase ventilation in the room.
4. In case of rooms where the ventilation through ventilation ducts is not working properly, the room should be ventilated by complete opening of the window.
5. By turning the handle to vertical position, the sash can be manually opened up to an angle of 180 degrees.
6. Lock situated in the side part of the window allows for safe and easy cleaning of the outer pane.
7. To ensure that the window functions reliably throughout its designed life, it is recommended to set up a program of maintenance. Remove leaves and other dirt from the flashing at least once a year to ensure proper water drainage. In areas with heavy snow falls, snow remaining for a long time should be removed. This allows to reduce the risk of freezing of melting snow on the window bottom element.
8. It is recommended to carry out periodical lubrication of hinges for their correct operation.
9. In case of wooden windows coated with ecological clear acrylic varnish it is recommended to paint them every 3-5 years depending on usage conditions.
10. The FTP-V, FTU-V WiFi window can be controlled by means of a button or using WiFi app.

CONTROL PANEL

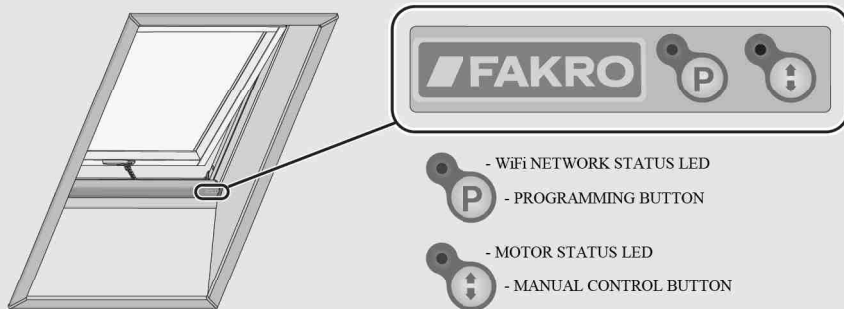

WiFi NETWORK STATUS SIGNALLING

 x1 **LED flashes once.**
Cause: Starting the device.

 **LED flashes once every 4 seconds.**
Cause: The device is assigned to the WiFi network and connected to the power supply. Remote control is possible.

 **LED is off.**
Cause: No power supply or deactivated signalling.

MOVEMENT SIGNALLING

 x1 **LED flashes once.**
Cause 1: The actuator reached extreme position (maximum chain extension).
Cause 2: Current consumed by the actuator is too low. In the case of problems with operating please contact FAKRO Service Dept.

 x3 **LED flashes 3 times.**
Cause 1: The actuator reached extreme position (maximum chain insertion).
Cause 2: Current consumed by the actuator is too high. In the case of problems with operating please contact FAKRO Service Dept.

 **LED is on.**
Cause: Overload.

ADDITIONAL INFORMATION

WINDOW REMOVAL FROM WiFi NETWORK – Holding the programming button for 5 seconds removes the window from the WiFi network (operation completed – LED flashes 15 times).

WINDOW RESET – At any time, when the "P" button has not been used for 10 seconds:

- hold the programming button until LED starts flashing (for the first 4 seconds LED is on)
- within the next 12 seconds, press the programming button 5 times (LED will continue to flash during this time)
- once the 12-second period is over, LED will light up for a few seconds and then turn off

WINDOW SOFTWARE UPDATE – Remote update of the window software by means of an app is possible.

 Information on how to define additional functions can be found in the device control application.

MANUAL CONTROL



Operate the window by pressing manual control button: 1.Start, 2.Stop, 3. Start in the opposite direction...

WiFi DEVICES COMPATIBILITY

The WiFi network allows to integrate devices belonging to different categories: lighting, heating, domestic automatic control, etc. This product can be operated using any WiFi network. A router with Internet access is required.



All information on adding devices to the WiFi network can be found in manuals of these products.

QUICK START

wBox APP DOWNLOAD

Download the wBox app using QR code or install it from the store.



ANDROID



IOS

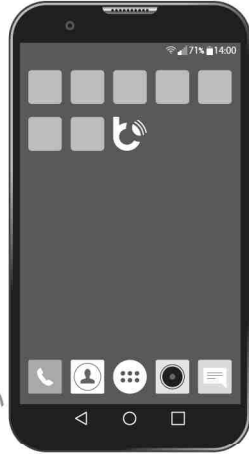

Follow the installer's instructions.

The application shortcut will be added to the home screen.



Test the products on a non-logged wBox app. When testing, do not press the blue '+' button. This generates network data and assigns the product to the user carrying out the test.



Do not allow automatic connection to the device's WiFi.

CONNECTION WITH THE DEVICE

- Direct control
- Option to control a single device



Connect with the device's network, eg my windowOpener.



Run the wBox app. Select the device from the list.



Control the device.

ADD DEVICE

uPORTAL

- Control via the Internet

ADD DEVICE TO APPLICATION AND WiFi NETWORK

- Control via WiFi and Internet
- Option to control many devices

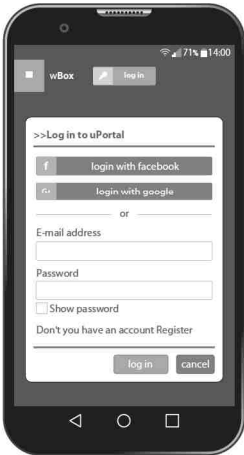

Turn on the Internet connection on your phone. Then register or log in to uPortal.



Connect with the device's network, eg my windowOpener.



Run wBox app. Add the device using "+" button.



Select the device from the list.

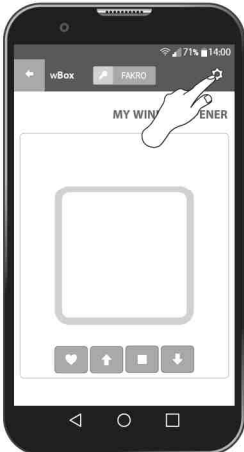

Enter settings of the selected device.



Scroll down the screen and select WiFi network that your device should connect to.



Control the device directly or via WiFi.

 The device administrator can grant remote access via uPortal.

 Connection status can be checked in the settings in the "WiFi client status" tab.

ACCESS TO DEVICE SETTINGS



Direct access or WiFi.
Settings available.



Access through Internet.
Settings not available.

CONTROL VIA APPLICATION



Open.



Close.



Select any position.



Stop.

 In the event of an error, eg "motor failure", operate the window to end positions or perform calibration.

COMFORT POSITION

This function allows to save favourite position that is reached after pressing one button.



Setting a comfort position.

Select requested position.



Hold the heart icon until the dashed line is in line with the current position (5 seconds).



Running a comfort position.

The actuator is in any position.



After pressing the heart icon, the actuator is back to the set position.

WINDOW CALIBRATION

The window has been factory calibrated. If control problems occur, recalibration can be performed.

This function is not available when connecting via the Internet.



Select the device from the list.

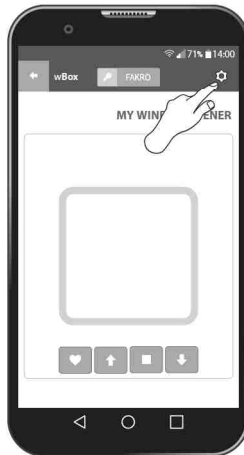

Enter the device settings.



Scroll down the screen and run "automatic calibration" (the process takes about 1 minute).



Once calibration is completed, a blue bar appears that is used to adjust the window position.

WARRANTY

The manufacturer guarantees correct device functioning. It also undertakes to repair or replace faulty device if damage is a result of material or structural faults. The warranty period is 24 months from the date of purchase, fulfilling the following conditions:

- Installation has been performed as per manufacturer recommendations.
- Seals remain intact and no authorised structural changes have been made.
- The device has been used in accordance with its intended use as per user manual.
- Damage is not a result of improperly made electrical system or atmospheric phenomena.
- The manufacturer is not liable for damage which occurred as a result of improper use or mechanical damage.

In case of failure, the device must be submitted for repair with a Warranty Card. Defects revealed within the warranty period will be removed free of charge no longer than 14 days after accepting the product for repair. Warranty and post-warranty repairs are performed by the manufacturer i.e. FAKRO PP. Sp. z o.o.

Producent:

FAKRO Sp. z o.o.

Ul. Węgierska 144A, 33-300 Nowy Sącz

Polska

www.fakro.com

tel.+ 48 18 444 0 444, fax. +48 18 444 0 333

Quality certificate:

Device

Model

Serial number

Seller

Address

Purchase date

Invoice No.

Signature (stamp) of person installing a device

